



Wireless Smoke Alarm

User's Manual



Important Safeguards and Warnings

This manual will help you to use the Device properly. Read the manual carefully before using the Device, and keep it well for future reference.

Operation Requirements

 **WARNING**

Never ignore any alarm. Failure to respond may lead to serious injury or death.

 **CAUTION**

- Make sure that the power supply of the device works properly before use.
- Use the device according to the operating environment.
- Only use the device within the rated power range.
- Transport, use and store the device under allowed humidity and temperature conditions.
- Prevent liquids from splashing or dripping on the device. Make sure that there are no objects filled with liquid on top of the device to avoid liquids flowing into it.
- The smoke alarm is only designed for indicating the presence of smoke, but it cannot detect gas, heat or flames.

Installation Requirements

 **WARNING**

- Strictly abide by local electrical safety standards, and make sure that the voltage in the area is steady and conforms to the power requirements of the device.
- Failure to properly install and operate this device will prevent proper operation of the Device and will prevent its response to fire hazards.

 **CAUTION**

- Observe all safety procedures and wear required protective equipment provided for your use while working at heights.
- Do not expose the device to direct sunlight or heat sources.
- Keep the original packing material well because you might need it to pack the device and send it back for repair.
- Make sure the application scenario conforms to installation requirements. Contact your local retailer or customer service center if there is any problem.
- All installation and operations shall conform to your local electrical safety requirements, fire protection regulations, and other relevant regulations.

Maintenance Requirements

- Do not clean the device with any cleaning products.

- Do not paint the device. Paint will seal the bents and interfere with the sensor's ability to detect smoke.

Table of Contents

Important Safeguards and Warnings	I
1. Introduction	1
1.1 Product information	1
1.2 Product profile.....	1
2. Technical Information	2
3. Device Installation	3
3.1 Packing List	3
3.2 Installation Position	3
3.3 Installation Steps.....	4
4. Connecting to the Hub	6
5. Smoke Alarm Configuration	7
5.1 Viewing Status of the Smoke Alarm	7
5.2 Configuring the Wireless Smoke Alarm.....	8
6. Test and Maintenance	9
6.1 Test.....	9
6.2 Maintenance.....	9
7. Battery Replacement	10
8. FAQ	11
9. Disposal	12
Appendix 1 Cybersecurity Recommendations	13

1.Introduction

1.1 Product information

Wireless Smoke Alarm provides battery-powered smoke detection and alarm functions within a single unit. Advanced electronics in conjunction with a photoelectric smoke sensing chamber provide early detection of smoke and high immunity against unwanted alarms. This kind of smoke alarm does not require a mains supply and is suitable for general residential applications. Timely notification of the smoke alarm can be displayed on DMSS App in real time.

1.2 Product profile

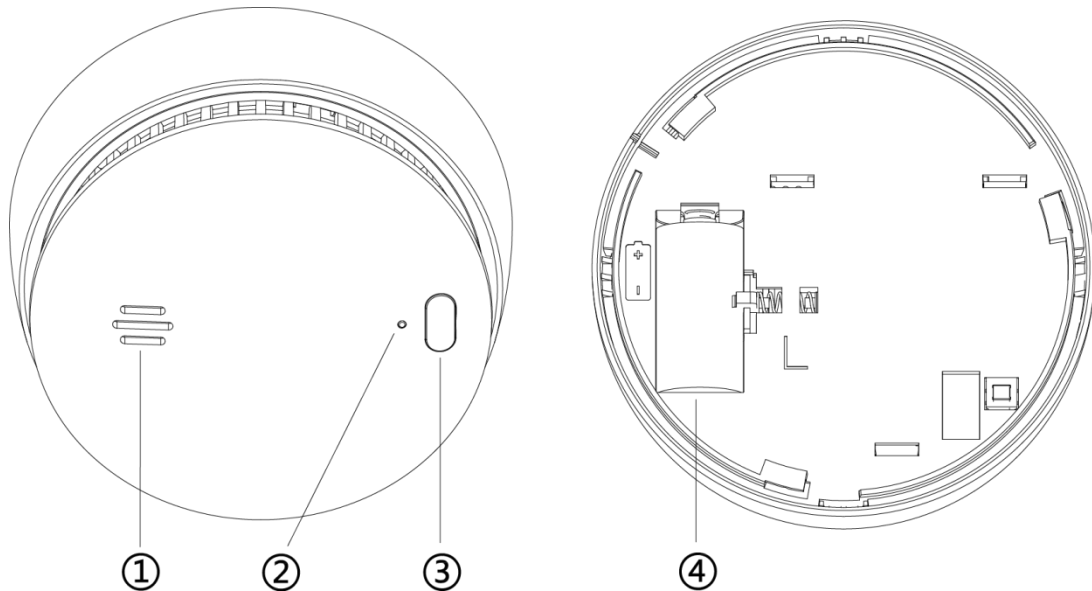

No.	Name	Introduction
1	Buzzer	Alarm Sound: 85dB (A) at 3 m (9.84 ft)
2	Indicator	<ul style="list-style-type: none"> Standby: Green indicator flashes once per minute Alarm: Red indicator flashes once per second Fault: Red indicator flashes once per minute
3	Test/Silence Button	<ul style="list-style-type: none"> Verify the normal working Stop the alarm sound
4	Battery Compartment	Replace the battery

2. Technical Information

Specification	Introduction
Model	DHI-HY-SA21A-W2, DHI-HY-SA21A-W2(868)
Sensor Type	Photoelectric
Supply Voltage	3V CR123A lithium battery (replaceable)
Battery Life	3 years
Alarm Method	Visual and audible alarm
Operating Current	<ul style="list-style-type: none"> Monitoring current: $\leq 35\mu\text{A}$ Alarm current: $\leq 35\text{mA}$
Operating Temperature	-10°C to $+55^{\circ}\text{C}$ ($+14^{\circ}\text{F}$ to $+131^{\circ}\text{F}$)
Operating Humidity	$\leq 95\%$ RH (non condensing)
Detecting Area	When the height of the space is less than 8 m (3.28 ft), the protection area of a device is 20 m^2 – 40 m^2
Dimensions	$\varnothing 98\text{mm} \times \text{H}43.1\text{mm}$ ($\varnothing 3.85" \times \text{H}1.70"$)
Weight (with battery)	140 g (0.30 lb)
Certification	EN 14604:2005+AC: 2008
Carrier Frequency	<ul style="list-style-type: none"> DHI-HY-SA21A-W2: 433.1 MHz–434.6 MHz DHI-HY-SA21A-W2(868): 868 MHz–868.3 MHz

3. Device Installation

3.1 Packing List

Check the package according to the following checklist. If you find device damage or any loss, contact the after-sales service.

Table 3-1 Checklist

Name	Quantity
Wireless Smoke Alarm	1
Positioning Map	1
Self-tapping Screw	2
Expansion Bolt	2
Mounting Plate	1
User's Manual	1

3.2 Installation Position



CAUTION

This device is intended for use in ordinary indoor locations of family living units. Construction and layout of individual dwellings will vary, so this should be regarded as a reference only. For further guidance, please check with your local fire station.

Figure 3-1 Overall layout



- Installed on the ceiling.
If the device is installed on the ceiling, install at a distance of 20 inches (500 mm) away from the corners of the room.

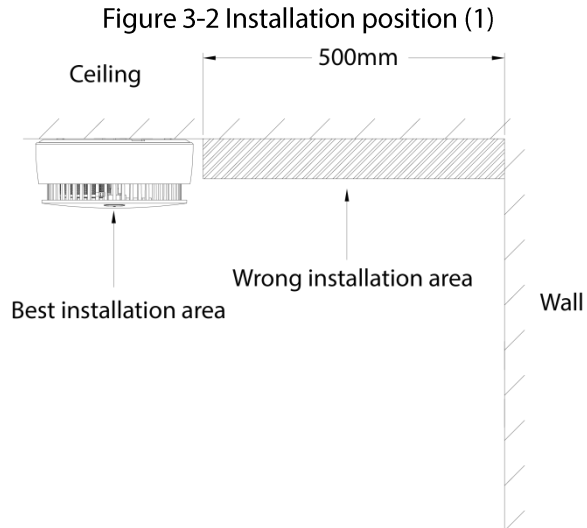

- Installed on the sloping roof.
 When the slope is less than 45° , the appropriate distance is 20 inches (500 mm). When the slope is more than 45° , a wood should be installed.

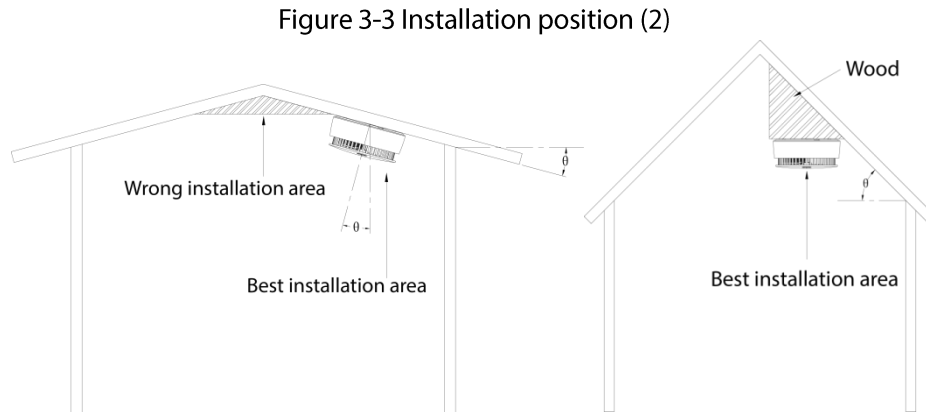

3.3 Installation Steps

Follow below steps to install the device properly.

Step 1 Choose suitable place to install positioning map.

Step 2 Drill holes ($\Phi 6$ mm [0.24"]) on the wall as the positioning map shows, and then align the screw holes on the wall with the expansion bolts.

Step 3 Fix the mounting plate with self-tapping screws.

Figure 3-4 Installation step (1)

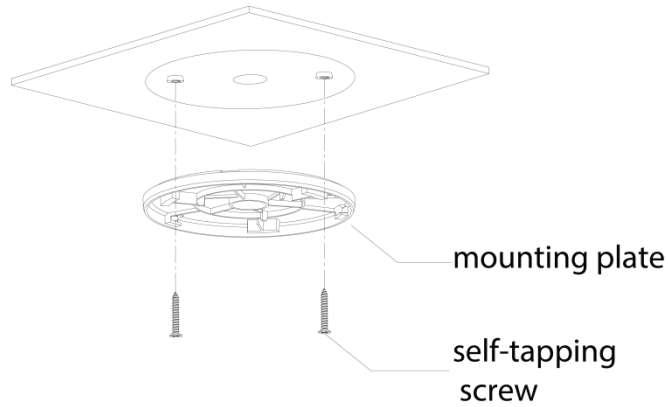

Step 4 Install the Device.

- 1) Correctly insert the lead wires, install the battery into the battery compartment according to the marked positive and negative polarity, and arrange the wiring harness.
- 2) Rotate the device according to the corresponding position and direction as shown in the figure.



NOTE

Please ensure it is firm.

Figure 3-5 Installation step (2)

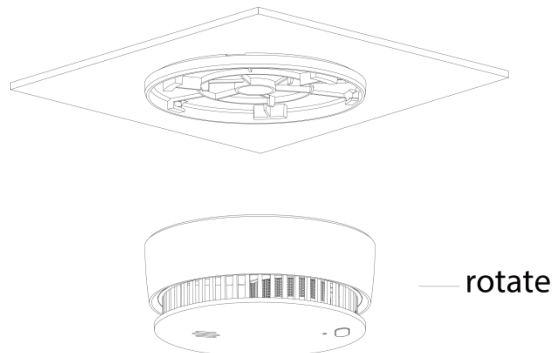

4.Connecting to the Hub

Before you connect it to the hub, install the DMSS app to your phone. Interfaces and functions might vary with different added devices, and the actual interface shall prevail. This manual uses iOS as an example.



- Make sure that you have already created an account, and added the hub to DMSS.
- Make sure that the hub has a stable internet connection.
- Make sure that the hub is disarmed.

Step 1 Go to the **Hub** screen, and then tap  to add the Wireless Smoke Alarm.

Step 2 Tap  to scan the QR code at the back of the Wireless Smoke Alarm, and then tap **Next**.

Step 3 Select Wireless Smoke Alarm on **Accessory** screen, and tap **Next** after the Wireless Smoke Alarm has been found.

Step 4 Follow the on-screen instructions and switch the Wireless Smoke Alarm to on, press and hold the **Test/Silence** button for 5 s ~10 s and then tap **Next**.

Step 5 Wait for the pairing.

Step 6 Customize the name of the Wireless Smoke Alarm, and select the area, and then tap **Completed**.













5. Smoke Alarm Configuration

You can view and edit general information of the Wireless Smoke Alarm.

5.1 Viewing Status of the Smoke Alarm

On the **Hub** screen, select a Smoke Alarm from the accessory list, and then you can view the status of the Wireless Smoke Alarm.

Table 5-1 Status

Parameter	Description
Signal Strength	The signal strength between the hub and the Wireless Smoke Alarm. <ul style="list-style-type: none"> • : Ultra low. • : Low. • : Moderate. • : High. • : No.
Battery Level	The battery level of the Wireless Smoke Alarm. <ul style="list-style-type: none"> • : Fully charged. • : Sufficient. • : Moderate. • : Insufficient.
Anti-tampering Status	Anti-tampering status of the Wireless Smoke Alarm.
Online Status	Online and offline status of the Wireless Smoke Alarm. <ul style="list-style-type: none"> • : Online. • : Offline.
Relay Status	The status of whether the Wireless Smoke Alarm forwards accessory messages to the hub through the repeater.  <p>The function is only available when the version of the DMSS app is 1.96 or later, and the hub is V1.001.0000000.6.R.211215 or later.</p>
Program Version	The program version of Wireless Smoke Alarm.

5.2 Configuring the Wireless Smoke Alarm



On the **Hub** screen, select a Smoke Alarm from the accessory list, and then tap  to configure the parameters of the Wireless Smoke Alarm.

Table 5-2 Wireless Smoke Alarm parameter description

Parameter	Description
Device Configuration	<ul style="list-style-type: none"> View device name, type, SN and device model. Edit device name, and then tap Save to save configuration.
Area	Select the area to which the Wireless Smoke Alarm is assigned.
Siren Linkage	When an alarm is triggered, the accessories will report the alarm events to the hub and alert with siren.
Alarm-video Linkage	When an alarm is triggered, the accessories will report the alarm events to the hub and then will be linked with videos.
Video Channel	Select the video channel as needed.
LED Indicator	<p>LED Indicator is enabled by default to turn on the LED indicator. For details on indicator behavior, see "1.2Product profile".</p>  <p>If LED Indicator is disabled, the LED indicator will remain off regardless of fault or alarm.</p>
Transmit Power	<ul style="list-style-type: none"> Select from high, low, and automatic. The higher the transmission power, the farther the transmission and the higher power consuming.
Signal Strength Detection	Test the current signal strength.
Cloud Update	Update online.
Delete	<p>Delete the online accessory.</p>  <p>Go to the Hub screen, select the accessory from the list, and then swipe left to delete it.</p>

6. Test and Maintenance

6.1 Test

After the installation of the Device or regular maintenance, a test must be carried out to confirm that the Device is operating properly.

During the testing process, the defective Device should be addressed according to "FAQ" and "Maintenance", and then tested again. If it fails to complete the test successfully, please send the Device to the manufacturer for repair.

Device self-test

Press the **Test/Silence** button, indicator light flashes quickly and buzzer beeps.

Alarm test

When the smoke concentration reaches predetermined threshold, the indicator light flashes and the Device sends out visual and audible alarm. Press **Test/Silence** button to stop alarm sound. When the concentration is lower than the predetermined value, the Device returns to its normal working state.

Low voltage

When the battery voltage is lower than a certain threshold, indicator flashes and the buzzer beeps every minute until the battery is depleted. Please immediately replace the battery with approved types. After replacing the battery, it is recommended to test your smoke alarm every week.

6.2 Maintenance

To keep your device in good working condition, please follow these requirements.

- Simulate fire alarm test: Test the device once a week.
Under normal working conditions, press the **Test/Silence** button to ensure that the Device can work normally. If there is a malfunction, please repair it in time. After cleaning, please install the Device and test again.
- Clean the shell: Clean the device at least once per year (recommended).
Keep the Device free of dust or inserts by gently vacuuming the shell with a soft brush attachment when required. Avoid cleaning solutions on the Device to prevent the possibility of contaminating the sensor.

7. Battery Replacement

When device has low battery warning, please replace battery immediately. Test the alarm for correct operation using test facility, whenever the battery is replaced. During the replacement, please pay attention to the positive and negative polarity markings. Only the following batteries can be replaced. Use of a battery other than those recommended below may have a detrimental effect on the device's operation.



NOTE

Recommended battery: EVE CR123A, PAIRDEER CR123A, RAMWAY CR123A, LISUN CR123A, HCB CR123A.



WARNING

Test the device for correct operation according to EN requirement every time after battery replacement.

Figure 7-1 Battery replacement

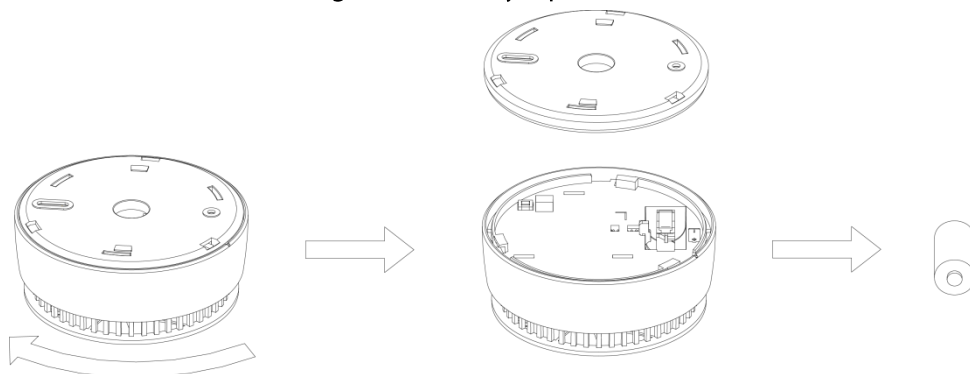

8.FAQ

Problem	Solutions
Your smoke alarm does not sound during testing	<ul style="list-style-type: none">• If testing immediately after first activating the alarm or replacing the batteries, you should allow a few seconds for the alarm to settle before testing.• Make sure you push the test button firmly.• Make sure you remove the transparent plastic cover of the battery.
Your smoke alarm chirps intermittently	<ul style="list-style-type: none">• Check the location of your smoke alarm (see "Installation Position").• Clean the smoke alarm (see "Test and Maintenance").
The LED indicator flashes red and the alarm sounds one beep every 60 seconds	<ul style="list-style-type: none">• The device is under low battery condition, please replace the battery immediately.• If the problem still exists after battery replacement, please contact technical support for advice.

9.Disposal



Waste electrical products should not be disposed of your other household waste. Please dispose in an environmentally friendly manner, and strictly follow the local regulations regarding the disposal or recycling of the electrical device.



WARNING

Do not burn or dispose of in fire.

Appendix 1 Cybersecurity Recommendations

Cybersecurity is more than just a buzzword: it's something that pertains to every device that is connected to the internet. IP video surveillance is not immune to cyber risks, but taking basic steps toward protecting and strengthening networks and networked appliances will make them less susceptible to attacks. Below are some tips and recommendations from Dahua on how to create a more secured security system.

Mandatory actions to be taken for basic device network security:

1. Use Strong Passwords

Please refer to the following suggestions to set passwords.

- The length should not be less than 8 characters.
- Include at least two types of characters; character types include upper and lower case letters, numbers and symbols.
- Do not contain the account name or the account name in reverse order.
- Do not use continuous characters, such as 123, abc, etc.
- Do not use overlapped characters, such as 111, aaa, etc.

2. Update Firmware and Client Software in Time

- According to the standard procedure in Tech-industry, we recommend to keep your device (such as NVR, DVR, IP camera, etc.) firmware up-to-date to ensure the system is equipped with the latest security patches and fixes. When the device is connected to the public network, it is recommended to enable the "auto-check for updates" function to obtain timely information of firmware updates released by the manufacturer.
- We suggest that you download and use the latest version of client software.

"Nice to have" recommendations to improve your device network security:

1. Physical Protection

We suggest that you perform physical protection to device, especially storage devices. For example, place the device in a special computer room and cabinet, and implement well-done access control permission and key management to prevent unauthorized personnel from carrying out physical contacts such as damaging hardware, unauthorized connection of removable device (such as USB flash disk, serial port), etc.

2. Change Passwords Regularly

We suggest that you change passwords regularly to reduce the risk of being guessed or cracked.

3. Set and Update Passwords Reset Information Timely

The device supports password reset function. Please set up related information for password reset in time, including the end user's mailbox and password protection questions. If the information changes, please modify it in time. When setting password protection questions, it is suggested not to use those that can be easily guessed.

4. Enable Account Lock

The account lock feature is enabled by default, and we recommend you to keep it on to guarantee the account security. If an attacker attempts to log in with the wrong password several times, the corresponding account and the source IP address will be locked.

5. Change Default HTTP and Other Service Ports

We suggest you to change default HTTP and other service ports into any set of numbers between 1024–65535, reducing the risk of outsiders being able to guess which ports you are using.

6. Enable HTTPS

We suggest you to enable HTTPS, so that you visit Web service through a secure communication channel.

7. MAC Address Binding

We recommend you to bind the IP and MAC address of the gateway to the device, thus reducing the risk of ARP spoofing.

8. Assign Accounts and Privileges Reasonably

According to business and management requirements, reasonably add users and assign a minimum set of permissions to them.

9. Disable Unnecessary Services and Choose Secure Modes

If not needed, it is recommended to turn off some services such as SNMP, SMTP, UPnP, etc., to reduce risks.

If necessary, it is highly recommended that you use safe modes, including but not limited to the following services:

- SNMP: Choose SNMP v3, and set up strong encryption passwords and authentication passwords.
- SMTP: Choose TLS to access mailbox server.
- FTP: Choose SFTP, and set up strong passwords.
- AP hotspot: Choose WPA2-PSK encryption mode, and set up strong passwords.

10. Audio and Video Encrypted Transmission

If your audio and video data contents are very important or sensitive, we recommend that you use encrypted transmission function, to reduce the risk of audio and video data being stolen during transmission.

Reminder: encrypted transmission will cause some loss in transmission efficiency.

11. Secure Auditing

- Check online users: we suggest that you check online users regularly to see if the device is logged in without authorization.
- Check device log: By viewing the logs, you can know the IP addresses that were used to log in to your devices and their key operations.

12. Network Log

Due to the limited storage capacity of the device, the stored log is limited. If you need to save the log for a long time, it is recommended that you enable the network log function to ensure that the critical logs are synchronized to the network log server for tracing.

13. Construct a Safe Network Environment

In order to better ensure the safety of device and reduce potential cyber risks, we recommend:

- Disable the port mapping function of the router to avoid direct access to the intranet devices from external network.
- The network should be partitioned and isolated according to the actual network needs. If there are no communication requirements between two sub networks, it is suggested to use VLAN, network GAP and other technologies to partition the network, so as to achieve the network isolation effect.
- Establish the 802.1x access authentication system to reduce the risk of unauthorized access to private networks.
- Enable IP/MAC address filtering function to limit the range of hosts allowed to access the device.

More information

Please visit Dahua official website security emergency response center for security announcements and the latest security recommendations.

ENABLING A SAFER SOCIETY AND SMARTER LIVING

ZHEJIANG DAHUA VISION TECHNOLOGY CO., LTD.

Address: No.1199 Bin'an Road, Binjiang District, Hangzhou, P. R. China | Website: www.dahuasecurity.com | Postcode: 310053

Email: overseas@dahuatech.com | Fax: +86-571-87688815 | Tel: +86-571-87688883